

 LoadSafe

KU 363N

3x63A 690V AC-22

PRODUCT NUMBER	21460
GTIN	6419410214602
E-NUMBER FI	3600723
TECHNICAL NAME	3x63A 690V AC-22
ETIM CLASS	EC000216

MEASUREMENTS

HEIGHT	73 mm
WIDTH	50 mm
DEPTH	75 mm
VOLUME	0.2738 l
NET WEIGHT	0.2066 kg

LOGISTICAL DATA

SALES UNIT	1
PACKAGE SIZE 1	1
PACKAGE SIZE 1 DEPTH	75 mm
PACKAGE SIZE 1 HEIGHT	73 mm
PACKAGE SIZE 1 WIDTH	75 mm
PACKAGE SIZE 1 WEIGHT	0.2066 kg
PACKAGE SIZE 1 VOLUME	0.4106 l

DIMENSIONAL DRAWING

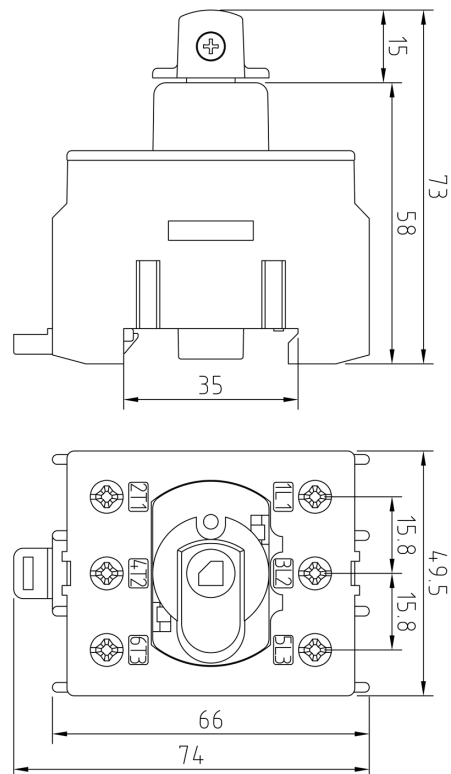

TECHNICAL DATA

NUMBER OF POLES	3
UL	UL 60947-4-1A
ATEX	No
RATED OPERATIONAL CURRENT AC-23A 415 V, IE (A)	40
RATED OPERATIONAL CURRENT AC-23A 690 V, IE (A)	40
RATED OPERATIONAL POWER, 3- PHASE 1500 RPM SQUIRREL-CAGE MOTOR AC-23A 690 V (KW)	37
RATED INSULATION VOLTAGE, UI (V)	800
AMPERE RATING (600V)	60
HP 208V	10
HP 480V	25
HP 600V	25
WIRE SIZE (CU ONLY)	12-4 AWG
NOMINAL VALUES WITH CABLE SIZE (MM ²)	25
RATED THERMAL CURRENT, ITH (A)	80
RATED OPERATIONAL CURRENT AC-21A 415 V, IE (A)	80
RATED OPERATIONAL CURRENT AC-21A 500 V, IE (A)	80
RATED OPERATIONAL CURRENT AC-21A 690 V, IE (A)	80
RATED OPERATIONAL CURRENT AC-22A 415 V, IE (A)	63
RATED OPERATIONAL CURRENT AC-22A 500 V, IE (A)	63
RATED OPERATIONAL CURRENT AC-22A 690 V, IE (A)	63

RATED OPERATIONAL CURRENT AC-23A 500 V, IE (A)	40
RATED OPERATIONAL POWER, 3- PHASE 1500 RPM SQUIRREL-CAGE MOTOR AC-23A 415 V (KW)	22
RATED OPERATIONAL POWER, 3- PHASE 1500 RPM SQUIRREL-CAGE MOTOR AC-23A 500 V (KW)	30
RATED FUSED SHORT-CIRCUIT CURRENT, BACK-UP FUSE OPTION 1 (A)	80
RATED FUSED SHORT-CIRCUIT CURRENT, R.M.S. IQ OPTION 1 (KA)	50
RATED FUSED SHORT-CIRCUIT CURRENT, PEAK VALUE (KA)	8.7
RATED IMPULSE WITHSTAND VOLTAGE, UIMP (KV)	8
RATED SHORT-CIRCUIT MAKING CAPACITY, ICM 690 V (KA)	2.5
RATED SHORT-TIME WITHSTAND CURRENT 1 S, ICW 690 V (KA)	2
RATED BREAKING CAPACITY, AC- 23A 415 V (A)	320
RATED BREAKING CAPACITY, AC- 23A 500 V (A)	320
RATED BREAKING CAPACITY, AC- 23A 690 V (A)	320
ELECTRICAL ENDURANCE (NUMBER OF OPERATIONS)	3000
MECHANICAL ENDURANCE (NUMBER OF OPERATIONS)	50000
TERMINAL / BOLT SIZE CU (MM ²)	2.5..35
MAXIMUM TERMINAL TORQUE (NM)	2.5
SWITCH TYPE	Load Break Switch