



LoadSafe KU 3400 SV

3x400A 690V AC-22



PRODUCT NUMBER	30029
GTIN	6419410300299
E-NUMBER FI	3602936
TECHNICAL NAME	3x400A 690V AC-22
ETIM CLASS	EC000216

MEASUREMENTS

HEIGHT	100 mm
WIDTH	204 mm
DEPTH	185 mm
VOLUME	3.774 l
NET WEIGHT	2.5422 kg

DIMENSIONAL DRAWING

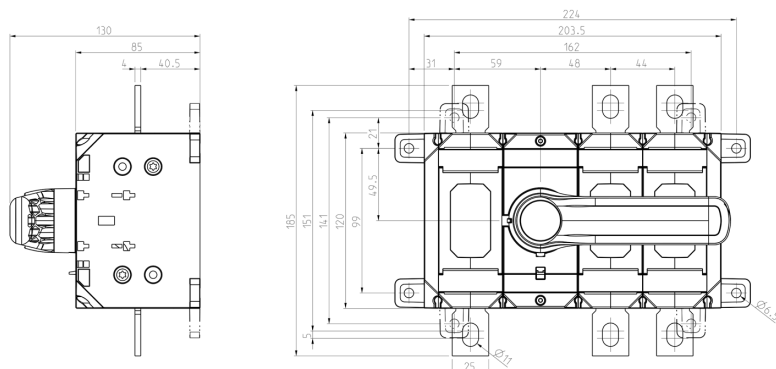

LOGISTICAL DATA

SALES UNIT	1
PACKAGE SIZE 1	1
PACKAGE SIZE 1	185 mm
DEPTH	
PACKAGE SIZE 1	100 mm
HEIGHT	
PACKAGE SIZE 1	185 mm
WIDTH	
PACKAGE SIZE 1	2.5422 kg
WEIGHT	
PACKAGE SIZE 1	3.4225 l
VOLUME	

TECHNICAL DATA

NUMBER OF POLES	3
ATEX	No
RATED OPERATIONAL CURRENT AC-23A 415 V, IE (A)	400
RATED OPERATIONAL CURRENT AC-23A 690 V, IE (A)	400
RATED OPERATIONAL POWER, 3- PHASE 1500 RPM SQUIRREL-CAGE MOTOR AC-23A 690 V (KW)	355
RATED INSULATION VOLTAGE, UI (V)	1000
NOMINAL VALUES WITH CABLE SIZE (MM ²)	240
RATED THERMAL CURRENT, ITH (A)	400
RATED OPERATIONAL CURRENT AC-21A 415 V, IE (A)	400
RATED OPERATIONAL CURRENT AC-21A 500 V, IE (A)	400
RATED OPERATIONAL CURRENT AC-21A 690 V, IE (A)	400
RATED OPERATIONAL CURRENT AC-22A 415 V, IE (A)	400
RATED OPERATIONAL CURRENT AC-22A 500 V, IE (A)	400
RATED OPERATIONAL CURRENT AC-22A 690 V, IE (A)	400
RATED OPERATIONAL CURRENT AC-22B 800 V, IE (A)	400
RATED OPERATIONAL CURRENT AC-23A 500 V, IE (A)	400
RATED OPERATIONAL CURRENT AC-23A 1000 V, IE (A)	200

RATED OPERATIONAL POWER, 3-PHASE 1500 RPM SQUIRREL-CAGE MOTOR AC-23A 415 V (KW)	200
RATED OPERATIONAL POWER, 3-PHASE 1500 RPM SQUIRREL-CAGE MOTOR AC-23A 500 V (KW)	250
RATED FUSED SHORT-CIRCUIT CURRENT, BACK-UP FUSE OPTION 1 (A)	400
RATED FUSED SHORT-CIRCUIT CURRENT, R.M.S. IQ OPTION 1 (KA)	100
RATED FUSED SHORT-CIRCUIT CURRENT, PEAK VALUE (KA)	42
RATED IMPULSE WITHSTAND VOLTAGE, UIMP (KV)	12
RATED SHORT-CIRCUIT MAKING CAPACITY, ICM 690 V (KA)	27.5
RATED SHORT-TIME WITHSTAND CURRENT 1 S, ICW 1000 V (KA)	13.5
RATED BREAKING CAPACITY, AC-23A 415 V (A)	3200
RATED BREAKING CAPACITY, AC-23A 500 V (A)	3200
RATED BREAKING CAPACITY, AC-23A 690 V (A)	3200
ELECTRICAL ENDURANCE (NUMBER OF OPERATIONS)	2000
MECHANICAL ENDURANCE (NUMBER OF OPERATIONS)	10000
TERMINAL / BOLT SIZE CU (MM ²)	M10
MAXIMUM TERMINAL TORQUE (NM)	30..44
SWITCH TYPE	Load Break Switch