

ConnectSafe KL3X95PE



PRODUCT NUMBER	20566
GTIN	6419410205662
E-NUMBER FI	1942140
ETIM CLASS	EC000897

MEASUREMENTS

HEIGHT	62.3 mm
WIDTH	67 mm
DEPTH	49 mm
VOLUME	0.2045 l
NET WEIGHT	0.295 kg

LOGISTICAL DATA

PACKAGE SIZE 1	6
PACKAGE SIZE 1 WEIGHT	0.295 kg

DIMENSIONAL DRAWING

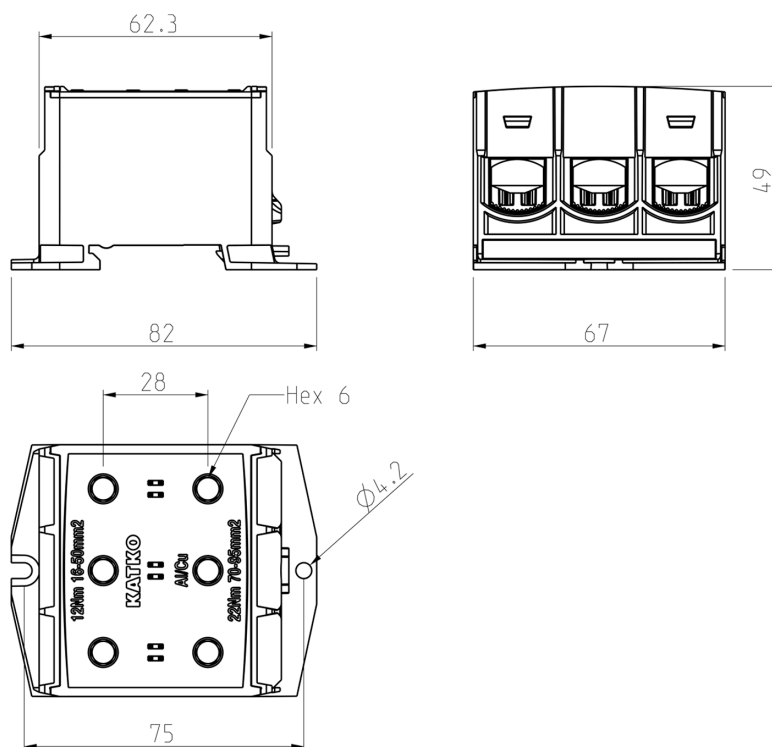

TECHNICAL DATA

ATEX	No
TORQUE AL/CU (NM)	12 (16 – 50 mm ²) / 22 (70 – 95 mm ²)
KEY SIZE	Hex 6
IN (AL) (A)	400
IN (CU) (A)	490
AL MM ²	6–95
CU MM ²	6–95
NOMINAL VOLTAGE	1000V AC / 1500V DC