



ConnectSafe KL1X50P

PRODUCT NUMBER	33808
GTIN	6419410338087
E-NUMBER FI	1942149
ETIM CLASS	EC000897

MEASUREMENTS

HEIGHT	59.5 mm
WIDTH	17.5 mm
DEPTH	41.5 mm
VOLUME	0.0432 l

LOGISTICAL DATA

PACKAGE SIZE 1	32
----------------	----

DIMENSIONAL DRAWING

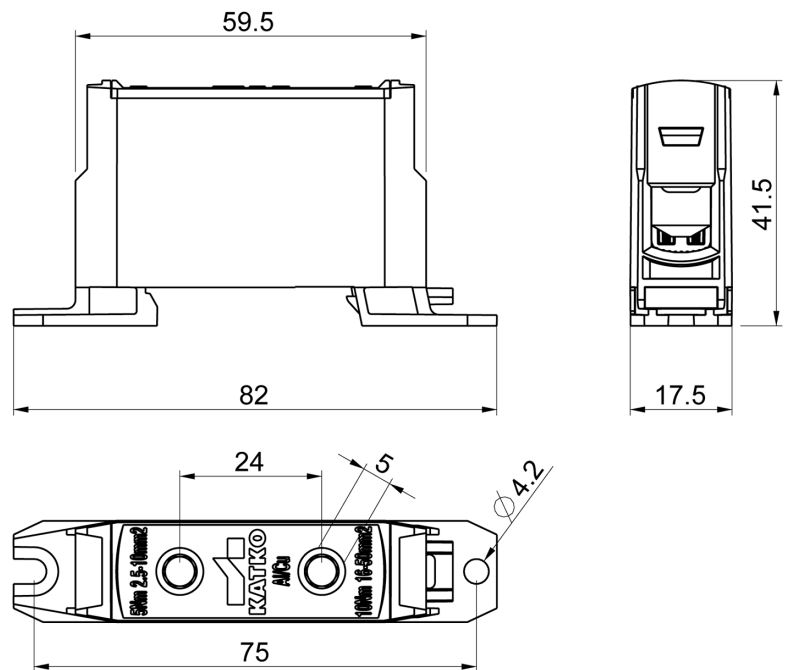

TECHNICAL DATA

ATEX	No
TORQUE AL/CU (NM)	5 (2,5 - 16 mm ²) / 10 (25 - 50 mm ²)
KEY SIZE	Hex 5
IN (AL) (A)	160
IN (CU) (A)	160
AL MM ²	2,5-50
CU MM ²	2,5-50
NOMINAL VOLTAGE	1000V AC / 1500V DC