

 IsoSafe

ISF 340UL RA2R

3x40A 400V 22kW

PRODUCT NUMBER	29426
GTIN	6419410294260
E-NUMBER FI	3662505
TECHNICAL NAME	3x40A 400V 22kW
ETIM CLASS	EC000216

MEASUREMENTS

HEIGHT	160 mm
WIDTH	120 mm
DEPTH	77 mm
VOLUME	1.4784 l

LOGISTICAL DATA

PACKAGE SIZE 1	77 mm
DEPTH	
PACKAGE SIZE 1	160 mm
HEIGHT	
PACKAGE SIZE 1	120 mm
WIDTH	
PACKAGE SIZE 1	1.4784 l
VOLUME	

DIMENSIONAL DRAWING

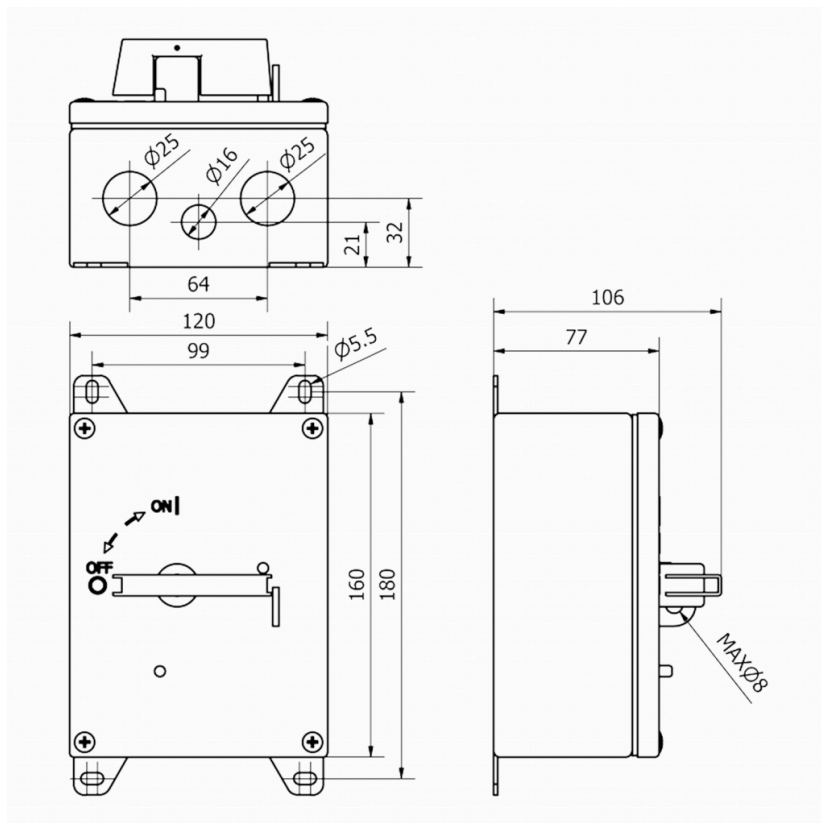

TECHNICAL DATA

NUMBER OF POLES	3
ENCLOSURE	RA2R (120 x 160 x 77 mm)
ENCLOSURE TYPE	Stainless steel enclosure (AISI 316L)
UL	UL 60947-4-1A
EMC	No
ATEX	No
IP RATING	IP66
AMPERE RATING (600V)	40
HP 208V	5
HP 480V	15
HP 600V	20
SWITCH TYPE DESCRIPTION	Manual motor controller
WIRE SIZE (CU ONLY)	14-8 AWG