



 IsoSafe

KEM 4400 MF03

4x400A 400V 200kW

PRODUCT NUMBER	32510
GTIN	6419410325100
TECHNICAL NAME	4x400A 400V 200kW
ETIM CLASS	EC000216

MEASUREMENTS

HEIGHT	560 mm
WIDTH	380 mm
DEPTH	180 mm
VOLUME	38.304 l
NET WEIGHT	10.8902 kg

LOGISTICAL DATA

SALES UNIT	1
PACKAGE SIZE 1	1
PACKAGE SIZE 1 DEPTH	180 mm
PACKAGE SIZE 1 HEIGHT	560 mm
PACKAGE SIZE 1 WIDTH	380 mm
PACKAGE SIZE 1 WEIGHT	10.8902 kg
PACKAGE SIZE 1 VOLUME	38.304 l

DIMENSIONAL DRAWING

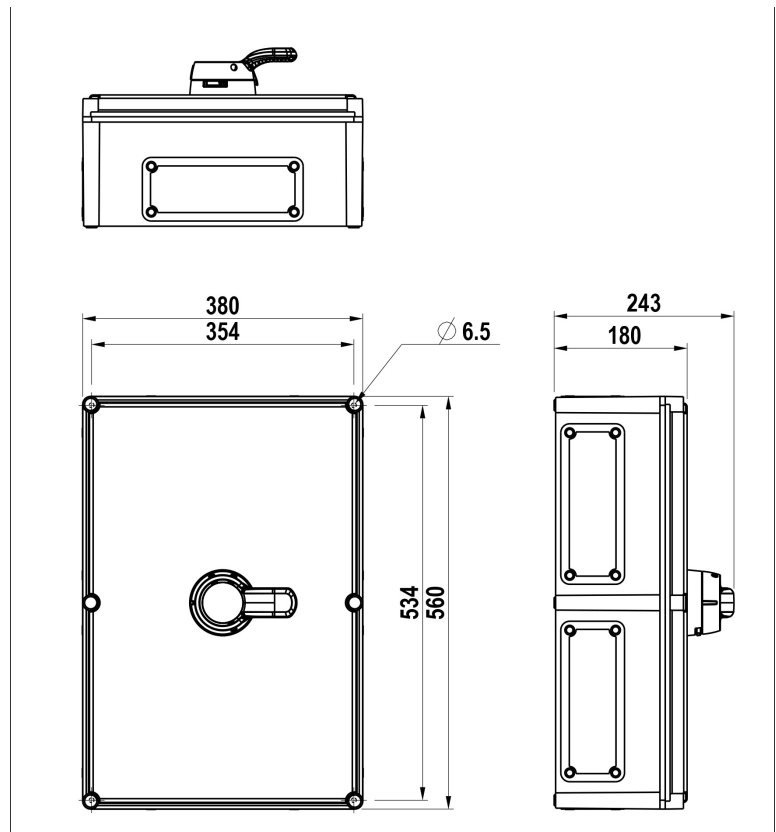

TECHNICAL DATA

NUMBER OF POLES	4
ENCLOSURE	MF03 (380 x 560 x 180 mm)
ENCLOSURE TYPE	Polycarbonate
EMC	No
ATEX	No
IP RATING	IP66
RATED OPERATIONAL CURRENT AC-23A 415 V, IE (A)	400
RATED OPERATIONAL CURRENT AC-23A 690 V, IE (A)	400
RATED OPERATIONAL POWER, 3- PHASE 1500 RPM SQUIRREL-CAGE MOTOR AC-23A 690 V (KW)	355
RATED INSULATION VOLTAGE, UI (V)	1000
SWITCH TYPE DESCRIPTION	Isolating switch
NOMINAL VALUES WITH CABLE SIZE (MM ²)	240
RATED THERMAL CURRENT, ITH (A)	400
RATED THERMAL CURRENT (ENCLOSED), ITHE (A)	400
RATED OPERATIONAL CURRENT AC-21A 415 V, IE (A)	400
RATED OPERATIONAL CURRENT AC-21A 500 V, IE (A)	400
RATED OPERATIONAL CURRENT AC-21A 690 V, IE (A)	400
RATED OPERATIONAL CURRENT AC-22A 415 V, IE (A)	400
RATED OPERATIONAL CURRENT AC-22A 500 V, IE (A)	400
RATED OPERATIONAL CURRENT AC-22A 690 V, IE (A)	400

RATED OPERATIONAL CURRENT AC-22B 800 V, IE (A)	400
RATED OPERATIONAL CURRENT AC-23A 500 V, IE (A)	400
RATED OPERATIONAL CURRENT AC-23A 1000 V, IE (A)	200
RATED OPERATIONAL POWER, 3- PHASE 1500 RPM SQUIRREL-CAGE MOTOR AC-23A 415 V (KW)	200
RATED OPERATIONAL POWER, 3- PHASE 1500 RPM SQUIRREL-CAGE MOTOR AC-23A 500 V (KW)	250
RATED FUSED SHORT-CIRCUIT CURRENT, BACK-UP FUSE OPTION 1 (A)	400
RATED FUSED SHORT-CIRCUIT CURRENT, R.M.S. IQ OPTION 1 (KA)	100
RATED FUSED SHORT-CIRCUIT CURRENT, PEAK VALUE (KA)	42
RATED IMPULSE WITHSTAND VOLTAGE, UIMP (KV)	12
RATED SHORT-CIRCUIT MAKING CAPACITY, ICM 690 V (KA)	27.5
RATED SHORT-TIME WITHSTAND CURRENT 1 S, ICW 1000 V (KA)	13.5
RATED BREAKING CAPACITY, AC- 23A 415 V (A)	3200
RATED BREAKING CAPACITY, AC- 23A 500 V (A)	3200
RATED BREAKING CAPACITY, AC- 23A 690 V (A)	3200
ELECTRICAL ENDURANCE (NUMBER OF OPERATIONS)	2000
MECHANICAL ENDURANCE (NUMBER OF OPERATIONS)	10000
TERMINAL / BOLT SIZE CU (MM ²)	M10
MAXIMUM TERMINAL TORQUE (NM)	30.44

SWITCH TYPE

Load Break Switch