



 IsoSafe
KEM 3250 MF03

3x250A 400V 132kW

PRODUCT NUMBER	32420
GTIN	6419410324202
TECHNICAL NAME	3x250A 400V 132kW
ETIM CLASS	EC000216

MEASUREMENTS

HEIGHT	560 mm
WIDTH	380 mm
DEPTH	180 mm
VOLUME	38.304 l
NET WEIGHT	9.2627 kg

LOGISTICAL DATA

SALES UNIT	1
PACKAGE SIZE 1	1
PACKAGE SIZE 1 DEPTH	180 mm
PACKAGE SIZE 1 HEIGHT	560 mm
PACKAGE SIZE 1 WIDTH	380 mm
PACKAGE SIZE 1 WEIGHT	9.2627 kg
PACKAGE SIZE 1 VOLUME	38.304 l

DIMENSIONAL DRAWING

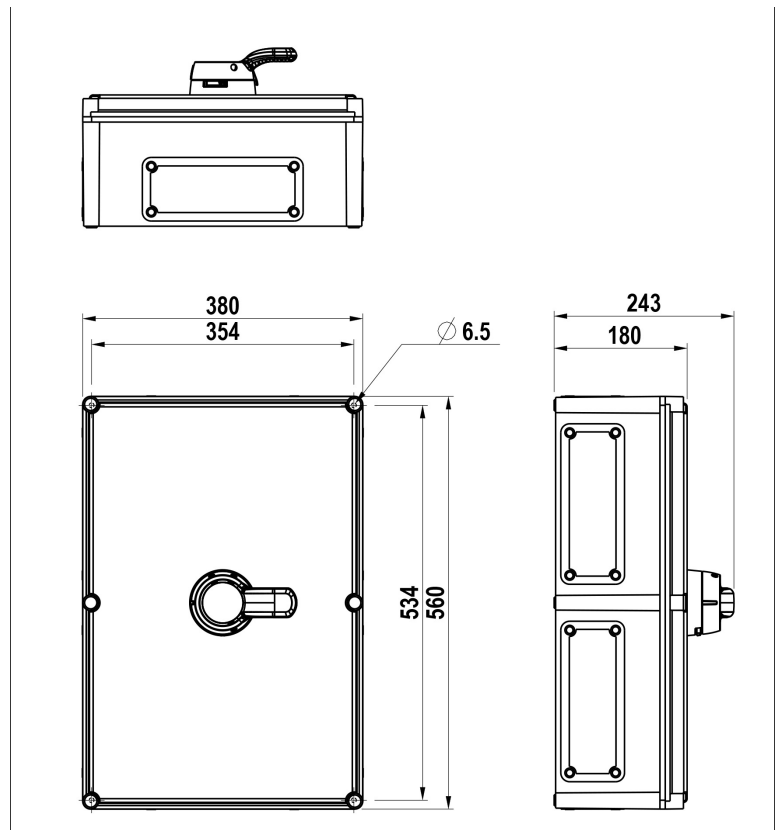

TECHNICAL DATA

NUMBER OF POLES	3
ENCLOSURE	MF03 (380 x 560 x 180 mm)
ENCLOSURE TYPE	Polycarbonate
EMC	No
ATEX	No
IP RATING	IP66
RATED OPERATIONAL CURRENT AC-23A 415 V, IE (A)	250
RATED OPERATIONAL CURRENT AC-23A 690 V, IE (A)	250
RATED OPERATIONAL POWER, 3- PHASE 1500 RPM SQUIRREL-CAGE MOTOR AC-23A 690 V (KW)	250
RATED INSULATION VOLTAGE, UI (V)	1000
SWITCH TYPE DESCRIPTION	Isolating switch
NOMINAL VALUES WITH CABLE SIZE (MM ²)	120
RATED THERMAL CURRENT, ITH (A)	315
RATED THERMAL CURRENT (ENCLOSED), ITHE (A)	315
RATED OPERATIONAL CURRENT AC-21A 415 V, IE (A)	250
RATED OPERATIONAL CURRENT AC-21A 500 V, IE (A)	250
RATED OPERATIONAL CURRENT AC-21A 690 V, IE (A)	250
RATED OPERATIONAL CURRENT AC-22A 415 V, IE (A)	250
RATED OPERATIONAL CURRENT AC-22A 500 V, IE (A)	250
RATED OPERATIONAL CURRENT AC-22A 690 V, IE (A)	250

RATED OPERATIONAL CURRENT AC-22A 800 V, IE (A)	250
RATED OPERATIONAL CURRENT AC-23A 500 V, IE (A)	250
RATED OPERATIONAL POWER, 3- PHASE 1500 RPM SQUIRREL-CAGE MOTOR AC-23A 415 V (KW)	132
RATED OPERATIONAL POWER, 3- PHASE 1500 RPM SQUIRREL-CAGE MOTOR AC-23A 500 V (KW)	160
RATED FUSED SHORT-CIRCUIT CURRENT, BACK-UP FUSE OPTION 1 (A)	250
RATED FUSED SHORT-CIRCUIT CURRENT, R.M.S. IQ OPTION 1 (KA)	100
RATED FUSED SHORT-CIRCUIT CURRENT, BACK-UP FUSE OPTION 2 (A)	315
RATED FUSED SHORT-CIRCUIT CURRENT, R.M.S. IQ OPTION 2 (KA)	50
RATED FUSED SHORT-CIRCUIT CURRENT, PEAK VALUE (KA)	26
RATED IMPULSE WITHSTAND VOLTAGE, UIMP (KV)	12
RATED SHORT-CIRCUIT MAKING CAPACITY, ICM 415 V (KA)	11.4
RATED SHORT-CIRCUIT MAKING CAPACITY, ICM 690 V (KA)	14
RATED SHORT-TIME WITHSTAND CURRENT 1 S, ICW 415 V (KA)	6.5
RATED SHORT-TIME WITHSTAND CURRENT 1 S, ICW 1000 V (KA)	8
RATED BREAKING CAPACITY, AC- 23A 415 V (A)	2000
RATED BREAKING CAPACITY, AC- 23A 500 V (A)	2000
RATED BREAKING CAPACITY, AC- 23A 690 V (A)	2000

ELECTRICAL ENDURANCE (NUMBER OF OPERATIONS)	2000
MECHANICAL ENDURANCE (NUMBER OF OPERATIONS)	16000
TERMINAL / BOLT SIZE CU (MM ²)	M8
MAXIMUM TERMINAL TORQUE (NM)	15..22
SWITCH TYPE	Load Break Switch