



PRODUCT NUMBER	30031
GTIN	6419410300312
E-NUMBER FI	3602937
TECHNICAL NAME	4x315A 690V AC-22
ETIM CLASS	EC000216

## MEASUREMENTS

HEIGHT	100 mm
WIDTH	248 mm
DEPTH	185 mm
VOLUME	4.588 l
NET WEIGHT	3.0058 kg

## DIMENSIONAL DRAWING

## LOGISTICAL DATA

SALES UNIT	1
PACKAGE SIZE 1	1
PACKAGE SIZE 1	185 mm
DEPTH	
PACKAGE SIZE 1	100 mm
HEIGHT	
PACKAGE SIZE 1	185 mm
WIDTH	
PACKAGE SIZE 1	3.0058 kg
WEIGHT	
PACKAGE SIZE 1	3.4225 l
VOLUME	

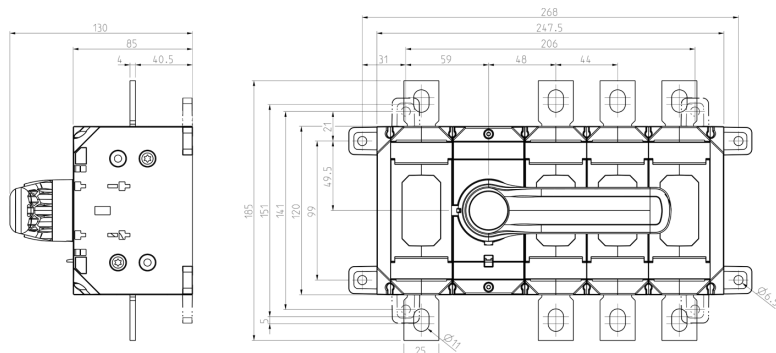

## TECHNICAL DATA

NUMBER OF POLES	4
ATEX	No
RATED OPERATIONAL CURRENT AC-23A 415 V, IE (A)	315
RATED OPERATIONAL CURRENT AC-23A 690 V, IE (A)	315
RATED OPERATIONAL POWER, 3- PHASE 1500 RPM SQUIRREL-CAGE MOTOR AC-23A 690 V (KW)	315
RATED INSULATION VOLTAGE, UI (V)	1000
NOMINAL VALUES WITH CABLE SIZE (MM <sup>2</sup> )	185
RATED THERMAL CURRENT, ITH (A)	315
RATED OPERATIONAL CURRENT AC-21A 415 V, IE (A)	315
RATED OPERATIONAL CURRENT AC-21A 500 V, IE (A)	315
RATED OPERATIONAL CURRENT AC-21A 690 V, IE (A)	315
RATED OPERATIONAL CURRENT AC-22A 415 V, IE (A)	315
RATED OPERATIONAL CURRENT AC-22A 500 V, IE (A)	315
RATED OPERATIONAL CURRENT AC-22A 690 V, IE (A)	315
RATED OPERATIONAL CURRENT AC-23A 500 V, IE (A)	315
RATED OPERATIONAL POWER, 3- PHASE 1500 RPM SQUIRREL-CAGE MOTOR AC-23A 415 V (KW)	160

RATED OPERATIONAL POWER, 3-PHASE 1500 RPM SQUIRREL-CAGE MOTOR AC-23A 500 V (KW)	200
RATED FUSED SHORT-CIRCUIT CURRENT, BACK-UP FUSE OPTION 1 (A)	400
RATED FUSED SHORT-CIRCUIT CURRENT, R.M.S. IQ OPTION 1 (KA)	100
RATED FUSED SHORT-CIRCUIT CURRENT, PEAK VALUE (KA)	42
RATED IMPULSE WITHSTAND VOLTAGE, UIMP (KV)	12
RATED SHORT-CIRCUIT MAKING CAPACITY, ICM 690 V (KA)	27.5
RATED SHORT-TIME WITHSTAND CURRENT 1 S, ICW 1000 V (KA)	13.5
RATED BREAKING CAPACITY, AC-23A 415 V (A)	2520
RATED BREAKING CAPACITY, AC-23A 500 V (A)	2520
RATED BREAKING CAPACITY, AC-23A 690 V (A)	2520
ELECTRICAL ENDURANCE (NUMBER OF OPERATIONS)	2000
MECHANICAL ENDURANCE (NUMBER OF OPERATIONS)	10000
TERMINAL / BOLT SIZE CU (MM <sup>2</sup> )	M10
MAXIMUM TERMINAL TORQUE (NM)	30..44
SWITCH TYPE	Load Break Switch