

 **ConnectSafe**
KKL1X50T3

1x2,5-50mm² Al/Cu

PRODUCT NUMBER	37872
GTIN	6419410378724
E-NUMBER FI	1942107
TECHNICAL NAME	1x2,5-50mm ² Al/Cu
ETIM CLASS	EC001284

MEASUREMENTS

HEIGHT	32 mm
WIDTH	17 mm
DEPTH	43 mm
VOLUME	0.0234 l
NET WEIGHT	0.0478 kg

LOGISTICAL DATA

PACKAGE SIZE 1	12
PACKAGE SIZE 1 WEIGHT	0.0478 kg

DIMENSIONAL DRAWING

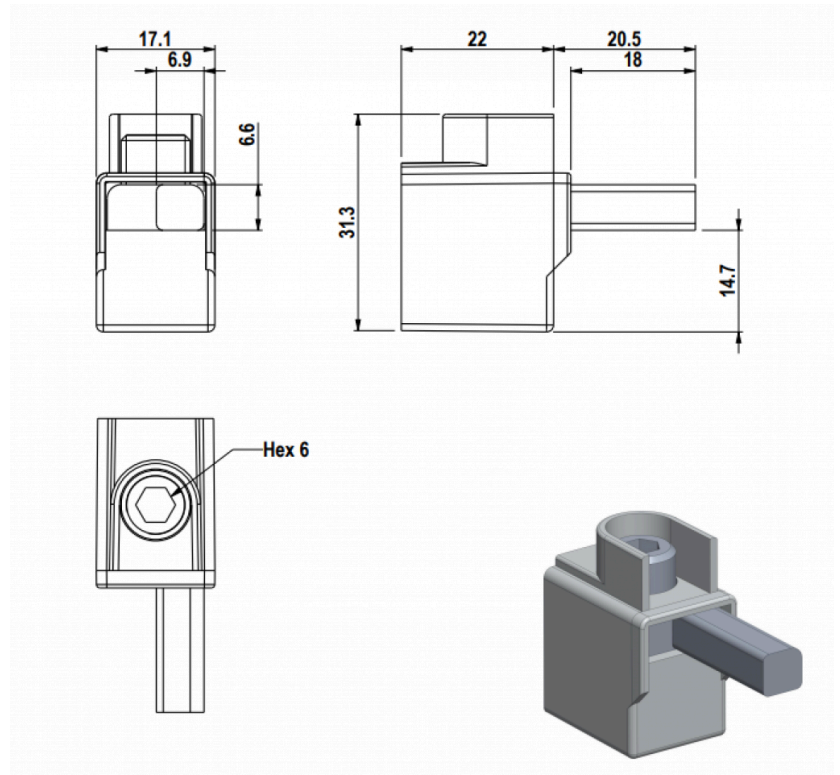

TECHNICAL DATA

ATEX	No
TORQUE AL/CU (NM)	5 (2,5-16mm ²) / 10 (25-50mm ²)
KEY SIZE	Hex 5
IN (AL) (A)	125
IN (CU) (A)	125
AL MM ²	16-50
CU MM ²	2,5-50