



IsoSafe

ISF 340UL A2

3x40A 400V 22kW



PRODUCT NUMBER	29453
GTIN	6419410294536
E-NUMBER FI	3662529
TECHNICAL NAME	3x40A 400V 22kW
ETIM CLASS	EC000216

MEASUREMENTS

HEIGHT	158.5 mm
WIDTH	104 mm
DEPTH	80 mm
VOLUME	1.3187 l
NET WEIGHT	1.0933 kg

DIMENSIONAL DRAWING

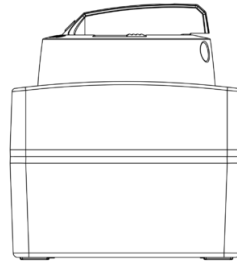

LOGISTICAL DATA

PACKAGE SIZE 1 DEPTH	80 mm
PACKAGE SIZE 1 HEIGHT	158.5 mm
PACKAGE SIZE 1 WIDTH	104 mm
PACKAGE SIZE 1 WEIGHT	1.0933 kg
PACKAGE SIZE 1 VOLUME	1.3187 l

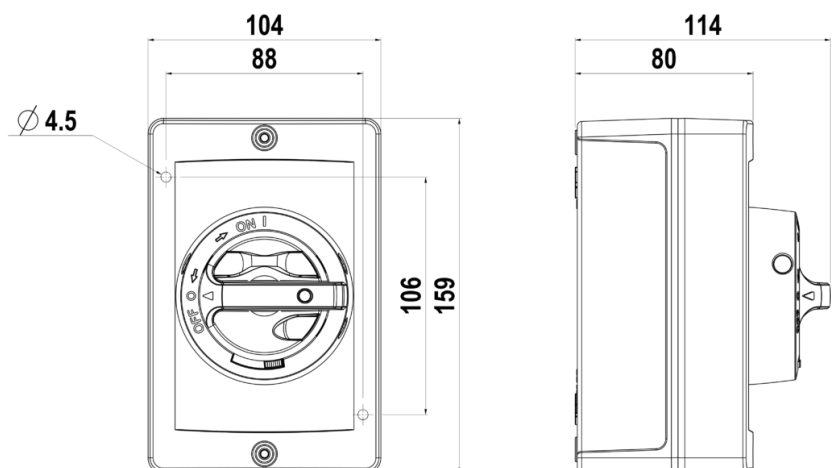

TECHNICAL DATA

NUMBER OF POLES	3
ENCLOSURE	A2 (104 x 159 x 80 mm)
ENCLOSURE TYPE	Aluminium
UL	UL 60947-4-1A
EMC	No
ATEX	No
IP RATING	IP66
AMPERE RATING (600V)	40
HP 208V	5
HP 480V	15
HP 600V	20
SWITCH TYPE DESCRIPTION	Manual motor controller
WIRE SIZE (CU ONLY)	14-8 AWG