

PRODUCT NUMBER	20690
GTIN	6419410206904
TECHNICAL NAME	4x250A 400V 132kW
ETIM CLASS	EC000216

## MEASUREMENTS

HEIGHT	657 mm
WIDTH	345 mm
DEPTH	222 mm
VOLUME	50.3196 l

## LOGISTICAL DATA

SALES UNIT	1
PACKAGE SIZE 1	1
PACKAGE SIZE 1	108 mm
DEPTH	
PACKAGE SIZE 1	262 mm
HEIGHT	
PACKAGE SIZE 1	162 mm
WIDTH	
PACKAGE SIZE 1	4.584 l
VOLUME	

## DIMENSIONAL DRAWING

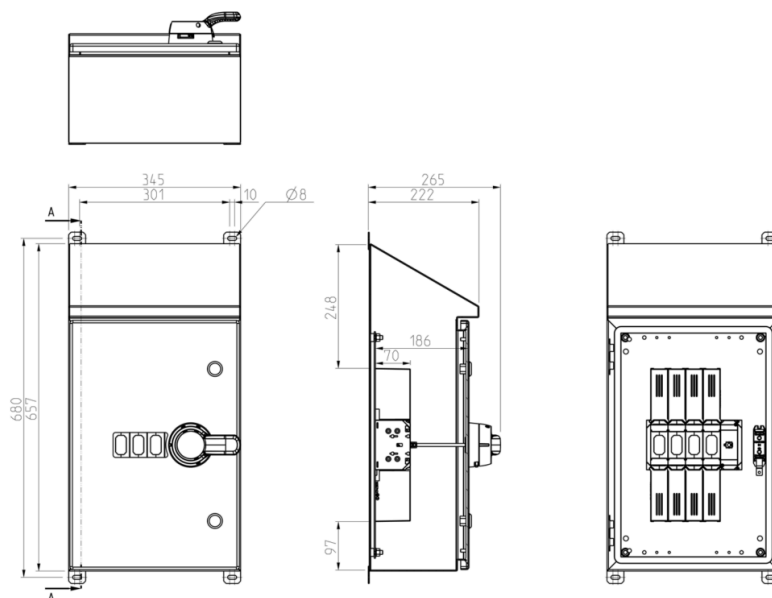

## TECHNICAL DATA

NUMBER OF POLES	4
ENCLOSURE	RA6AVS (345 x 657 x 222 mm)
ENCLOSURE TYPE	Stainless steel enclosure (AISI 316L)
EMC	No
ATEX	No
IP RATING	IP66
RATED OPERATIONAL CURRENT AC-23A 415 V, IE (A)	250
RATED OPERATIONAL CURRENT AC-23A 690 V, IE (A)	250
RATED OPERATIONAL POWER, 3-PHASE 1500 RPM SQUIRREL-CAGE MOTOR AC-23A 690 V (KW)	250
RATED INSULATION VOLTAGE, UI (V)	1000
SWITCH TYPE DESCRIPTION	Isolating switch
NOMINAL VALUES WITH CABLE SIZE (MM <sup>2</sup> )	120
RATED THERMAL CURRENT, ITH (A)	315
RATED THERMAL CURRENT (ENCLOSED), ITHE (A)	315
RATED OPERATIONAL CURRENT AC-21A 415 V, IE (A)	250
RATED OPERATIONAL CURRENT AC-21A 500 V, IE (A)	250
RATED OPERATIONAL CURRENT AC-21A 690 V, IE (A)	250
RATED OPERATIONAL CURRENT AC-22A 415 V, IE (A)	250
RATED OPERATIONAL CURRENT AC-22A 500 V, IE (A)	250
RATED OPERATIONAL CURRENT AC-22A 690 V, IE (A)	250

RATED OPERATIONAL CURRENT AC-22A 800 V, IE (A)	250
RATED OPERATIONAL CURRENT AC-23A 500 V, IE (A)	250
RATED OPERATIONAL POWER, 3- PHASE 1500 RPM SQUIRREL-CAGE MOTOR AC-23A 415 V (KW)	132
RATED OPERATIONAL POWER, 3- PHASE 1500 RPM SQUIRREL-CAGE MOTOR AC-23A 500 V (KW)	160
RATED FUSED SHORT-CIRCUIT CURRENT, BACK-UP FUSE OPTION 1 (A)	250
RATED FUSED SHORT-CIRCUIT CURRENT, R.M.S. IQ OPTION 1 (KA)	100
RATED FUSED SHORT-CIRCUIT CURRENT, BACK-UP FUSE OPTION 2 (A)	315
RATED FUSED SHORT-CIRCUIT CURRENT, R.M.S. IQ OPTION 2 (KA)	50
RATED FUSED SHORT-CIRCUIT CURRENT, PEAK VALUE (KA)	26
RATED IMPULSE WITHSTAND VOLTAGE, UIMP (KV)	12
RATED SHORT-CIRCUIT MAKING CAPACITY, ICM 415 V (KA)	11.4
RATED SHORT-CIRCUIT MAKING CAPACITY, ICM 690 V (KA)	14
RATED SHORT-TIME WITHSTAND CURRENT 1 S, ICW 415 V (KA)	6.5
RATED SHORT-TIME WITHSTAND CURRENT 1 S, ICW 1000 V (KA)	8
RATED BREAKING CAPACITY, AC- 23A 415 V (A)	2000
RATED BREAKING CAPACITY, AC- 23A 500 V (A)	2000
RATED BREAKING CAPACITY, AC- 23A 690 V (A)	2000

ELECTRICAL ENDURANCE (NUMBER OF OPERATIONS)	2000
MECHANICAL ENDURANCE (NUMBER OF OPERATIONS)	16000
TERMINAL / BOLT SIZE CU (MM <sup>2</sup> )	M8
MAXIMUM TERMINAL TORQUE (NM)	15..22
SWITCH TYPE	Load Break Switch