



 FuseSafe
KVKEM 3200 MF03

3x250 400V 132kW

PRODUCT NUMBER	39756
GTIN	6419410397565
ETIM CLASS	EC001040

MEASUREMENTS

HEIGHT	560 mm
WIDTH	380 mm
DEPTH	180 mm
VOLUME	38.304 l
NET WEIGHT	10.7583 kg

LOGISTICAL DATA

SALES UNIT	1
PACKAGE SIZE 1	1
PACKAGE SIZE 1 DEPTH	180 mm
PACKAGE SIZE 1 HEIGHT	560 mm
PACKAGE SIZE 1 WIDTH	380 mm
PACKAGE SIZE 1 WEIGHT	10.7583 kg
PACKAGE SIZE 1 VOLUME	38.304 l

DIMENSIONAL DRAWING

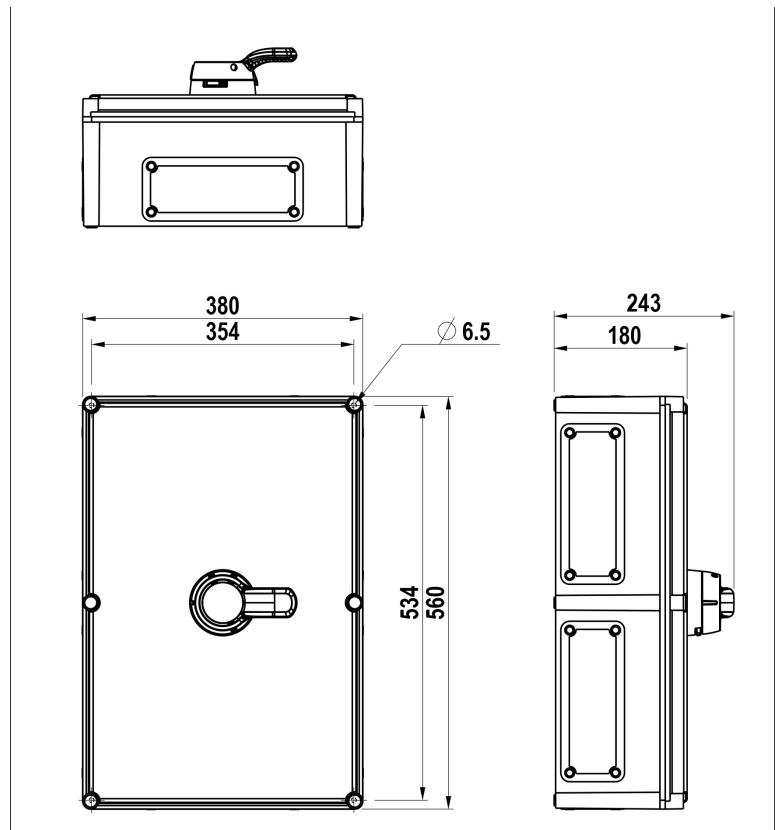

TECHNICAL DATA

NUMBER OF POLES	3
ENCLOSURE	MF03 (380 x 560 x 180 mm)
ENCLOSURE TYPE	Polycarbonate
ATEX	No
RATED OPERATIONAL CURRENT AC-23A 415 V, IE (A)	200
RATED OPERATIONAL CURRENT AC-23A 690 V, IE (A)	200
RATED OPERATIONAL POWER, 3- PHASE 1500 RPM SQUIRREL-CAGE MOTOR AC-23A 690 V (KW)	160
RATED INSULATION VOLTAGE, UI (V)	1000
NOMINAL VALUES WITH CABLE SIZE (MM ²)	95
RATED THERMAL CURRENT, ITH (A)	200
RATED THERMAL CURRENT (ENCLOSED), ITHE (A)	200
RATED OPERATIONAL CURRENT AC-21A 415 V, IE (A)	200
RATED OPERATIONAL CURRENT AC-21A 500 V, IE (A)	200
RATED OPERATIONAL CURRENT AC-21A 690 V, IE (A)	200
RATED OPERATIONAL CURRENT AC-22A 415 V, IE (A)	200
RATED OPERATIONAL CURRENT AC-22A 500 V, IE (A)	200
RATED OPERATIONAL CURRENT AC-22A 690 V, IE (A)	200
RATED OPERATIONAL CURRENT AC-23A 240 V, IE (A)	200

RATED OPERATIONAL CURRENT AC-23A 500 V, IE (A)	200
RATED OPERATIONAL POWER, 3- PHASE 1500 RPM SQUIRREL-CAGE MOTOR AC-23A 415 V (KW)	110
RATED OPERATIONAL POWER, 3- PHASE 1500 RPM SQUIRREL-CAGE MOTOR AC-23A 500 V (KW)	132
RATED FUSED SHORT-CIRCUIT CURRENT, BACK-UP FUSE OPTION 1 (A)	200
RATED FUSED SHORT-CIRCUIT CURRENT, R.M.S. IQ OPTION 1 (KA)	50
RATED IMPULSE WITHSTAND VOLTAGE, UIMP (KV)	12
RATED SHORT-CIRCUIT MAKING CAPACITY, ICM 690 V (KA)	7
RATED SHORT-TIME WITHSTAND CURRENT 1 S, ICW 690 V (KA)	5
RATED BREAKING CAPACITY, AC- 23A 415 V (A)	1600
RATED BREAKING CAPACITY, AC- 23A 500 V (A)	1600
RATED BREAKING CAPACITY, AC- 23A 690 V (A)	1600
ELECTRICAL ENDURANCE (NUMBER OF OPERATIONS)	2000
MECHANICAL ENDURANCE (NUMBER OF OPERATIONS)	16000
TERMINAL / BOLT SIZE CU (MM ²)	M10
MAXIMUM TERMINAL TORQUE (NM)	30..40
FUSE TYPE: DIN	1
SWITCH TYPE	Switch Fuse