

 IsoSafe

KEM 280 M3ABS

2x63A 400V 30kW

PRODUCT NUMBER	35402
GTIN	6419410354025
TECHNICAL NAME	2x63A 400V 30kW
ETIM CLASS	EC000216

MEASUREMENTS

HEIGHT	190 mm
WIDTH	144 mm
DEPTH	96 mm
VOLUME	2.6266 l
NET WEIGHT	0.6939 kg

LOGISTICAL DATA

SALES UNIT	1
PACKAGE SIZE 1	1
PACKAGE SIZE 1	96 mm
DEPTH	
PACKAGE SIZE 1	190 mm
HEIGHT	
PACKAGE SIZE 1	144 mm
WIDTH	
PACKAGE SIZE 1	0.6939 kg
WEIGHT	
PACKAGE SIZE 1	2.6266 l
VOLUME	

DIMENSIONAL DRAWING

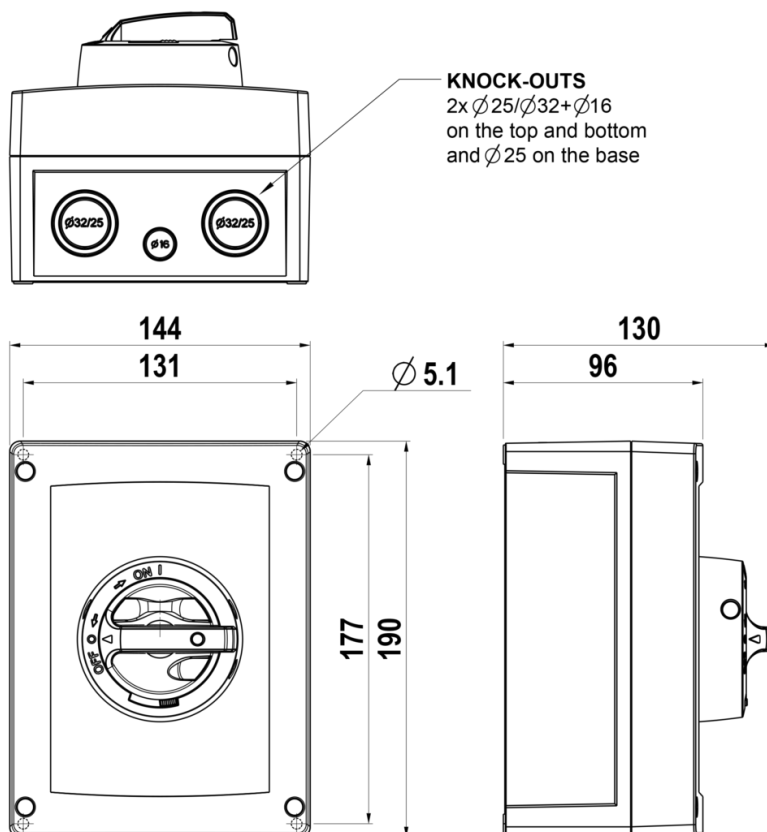

TECHNICAL DATA

NUMBER OF POLES	2
ENCLOSURE	M3 (144 x 190 x 96 mm)
ENCLOSURE TYPE	ABS plastic
EMC	No
ATEX	No
IP RATING	IP65
RATED OPERATIONAL CURRENT AC-23A 415 V, IE (A)	63
RATED OPERATIONAL POWER, 1- PHASE 1500 RPM SQUIRREL-CAGE MOTOR AC-23A 240 V (KW)	11
RATED INSULATION VOLTAGE, UI (V)	800
SWITCH TYPE DESCRIPTION	Isolating switch
NOMINAL VALUES WITH CABLE SIZE (MM ²)	35
RATED THERMAL CURRENT, ITH (A)	100
RATED THERMAL CURRENT (ENCLOSED), ITHE (A)	100
RATED OPERATIONAL CURRENT AC-21A 415 V, IE (A)	100
RATED OPERATIONAL CURRENT AC-22A 415 V, IE (A)	80
RATED OPERATIONAL CURRENT AC-23A 240 V, IE (A)	63
RATED FUSED SHORT-CIRCUIT CURRENT, BACK-UP FUSE OPTION 1 (A)	80
RATED FUSED SHORT-CIRCUIT CURRENT, R.M.S. IQ OPTION 1 (KA)	50
RATED FUSED SHORT-CIRCUIT CURRENT, PEAK VALUE (KA)	8.2
RATED IMPULSE WITHSTAND VOLTAGE, UIMP (KV)	8

RATED SHORT-CIRCUIT MAKING CAPACITY, ICM 690 V (KA)	2.5
RATED SHORT-TIME WITHSTAND CURRENT 1 S, ICW 690 V (KA)	2
RATED BREAKING CAPACITY, AC-23A 415 V (A)	504
ELECTRICAL ENDURANCE (NUMBER OF OPERATIONS)	3000
MECHANICAL ENDURANCE (NUMBER OF OPERATIONS)	50000
TERMINAL / BOLT SIZE CU (MM ²)	2.5..35
MAXIMUM TERMINAL TORQUE (NM)	2.5
SWITCH TYPE	Load Break Switch