



FuseSafe KVKET 3100 T5

3x125 400V 55kW

PRODUCT NUMBER	22330
GTIN	6419410223307
ETIM CLASS	EC001040

MEASUREMENTS

HEIGHT	400 mm
WIDTH	300 mm
DEPTH	150 mm
VOLUME	18 l
NET WEIGHT	8.887 kg

LOGISTICAL DATA

SALES UNIT	1
PACKAGE SIZE 1	1
PACKAGE SIZE 1	150 mm
DEPTH	
PACKAGE SIZE 1	400 mm
HEIGHT	
PACKAGE SIZE 1	300 mm
WIDTH	
PACKAGE SIZE 1	8.887 kg
WEIGHT	
PACKAGE SIZE 1	18 l
VOLUME	

DIMENSIONAL DRAWING

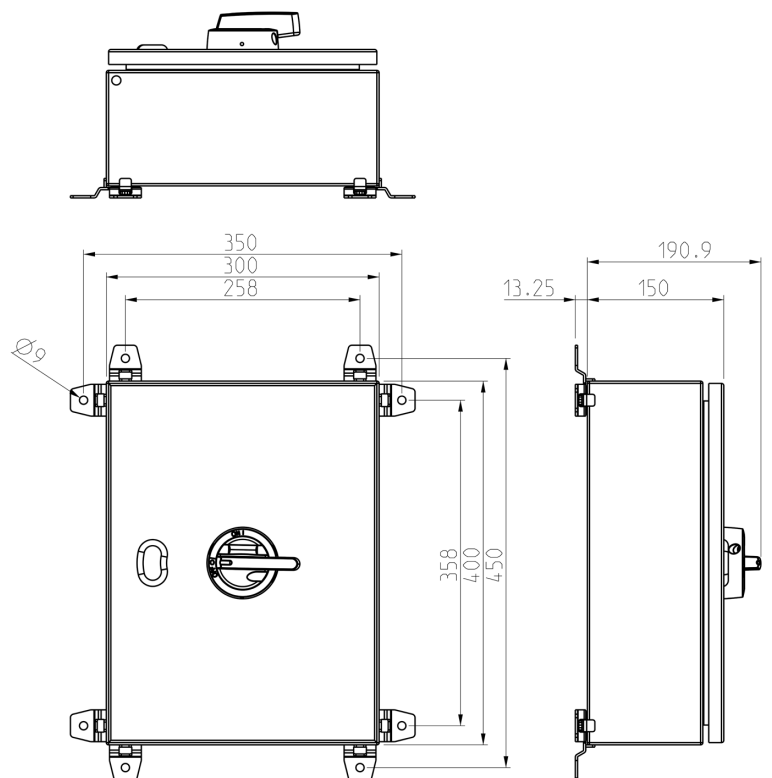

TECHNICAL DATA

NUMBER OF POLES	3
ENCLOSURE	T5 (300 x 400 x 150 mm)
ENCLOSURE TYPE	Painted sheet steel
ATEX	No
RATED OPERATIONAL CURRENT AC-23A 415 V, IE (A)	100
RATED OPERATIONAL CURRENT AC-23A 690 V, IE (A)	100
RATED OPERATIONAL POWER, 3- PHASE 1500 RPM SQUIRREL-CAGE MOTOR AC-23A 690 V (KW)	90
RATED INSULATION VOLTAGE, UI (V)	690
NOMINAL VALUES WITH CABLE SIZE (MM ²)	35
RATED THERMAL CURRENT, ITH (A)	100
RATED THERMAL CURRENT (ENCLOSED), ITHE (A)	100
RATED OPERATIONAL CURRENT AC-21A 415 V, IE (A)	100
RATED OPERATIONAL CURRENT AC-21A 500 V, IE (A)	100
RATED OPERATIONAL CURRENT AC-21A 690 V, IE (A)	100
RATED OPERATIONAL CURRENT AC-22A 415 V, IE (A)	100
RATED OPERATIONAL CURRENT AC-22A 500 V, IE (A)	100
RATED OPERATIONAL CURRENT AC-22A 690 V, IE (A)	100
RATED OPERATIONAL CURRENT AC-23A 500 V, IE (A)	100

RATED OPERATIONAL POWER, 3-PHASE 1500 RPM SQUIRREL-CAGE MOTOR AC-23A 415 V (KW)	55
RATED OPERATIONAL POWER, 3-PHASE 1500 RPM SQUIRREL-CAGE MOTOR AC-23A 500 V (KW)	55
RATED FUSED SHORT-CIRCUIT CURRENT, BACK-UP FUSE OPTION 1 (A)	100
RATED FUSED SHORT-CIRCUIT CURRENT, R.M.S. IQ OPTION 1 (KA)	50
RATED IMPULSE WITHSTAND VOLTAGE, UIMP (KV)	8
RATED SHORT-CIRCUIT MAKING CAPACITY, ICM 690 V (KA)	6
RATED SHORT-TIME WITHSTAND CURRENT 1 S, ICW 690 V (KA)	4
RATED BREAKING CAPACITY, AC-23A 415 V (A)	800
RATED BREAKING CAPACITY, AC-23A 500 V (A)	800
RATED BREAKING CAPACITY, AC-23A 690 V (A)	800
ELECTRICAL ENDURANCE (NUMBER OF OPERATIONS)	2000
MECHANICAL ENDURANCE (NUMBER OF OPERATIONS)	20000
TERMINAL / BOLT SIZE CU (MM ²)	6..70
MAXIMUM TERMINAL TORQUE (NM)	6
FUSE TYPE: DIN	000/00
SWITCH TYPE	Switch Fuse