

 LoadSafe

VKA 3200
L228AD12T6LK12
3x200A 400V 110kW

PRODUCT NUMBER	21802
GTIN	6419410218020
E-NUMBER FI	3609240
TECHNICAL NAME	3x200A 400V 110kW
ETIM CLASS	EC000216

MEASUREMENTS

HEIGHT	87 mm
WIDTH	129 mm
DEPTH	142 mm
VOLUME	1.5937 l

LOGISTICAL DATA

SALES UNIT	1
PACKAGE SIZE 1	1
PACKAGE SIZE 1	142 mm
DEPTH	
PACKAGE SIZE 1	87 mm
HEIGHT	
PACKAGE SIZE 1	142 mm
WIDTH	
PACKAGE SIZE 1	1.7543 l
VOLUME	

DIMENSIONAL DRAWING

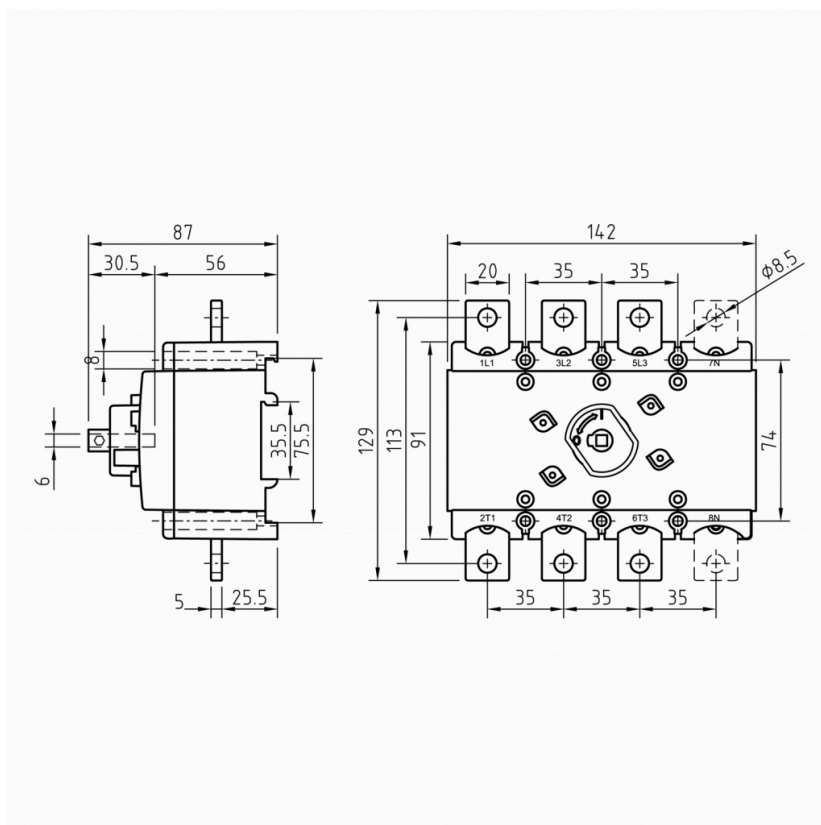

TECHNICAL DATA

NUMBER OF POLES	3
ATEX	No
RATED OPERATIONAL CURRENT AC-23A 415 V, IE (A)	200
RATED INSULATION VOLTAGE, UI (V)	1000
NOMINAL VALUES WITH CABLE SIZE (MM ²)	95
RATED THERMAL CURRENT, ITH (A)	200
RATED OPERATIONAL CURRENT AC-21A 415 V, IE (A)	200
RATED OPERATIONAL CURRENT AC-21A 500 V, IE (A)	200
RATED OPERATIONAL CURRENT AC-21A 690 V, IE (A)	200
RATED OPERATIONAL CURRENT AC-22A 415 V, IE (A)	200
RATED OPERATIONAL POWER, 3- PHASE 1500 RPM SQUIRREL-CAGE MOTOR AC-23A 415 V (KW)	110
RATED FUSED SHORT-CIRCUIT CURRENT, BACK-UP FUSE OPTION 1 (A)	250
RATED FUSED SHORT-CIRCUIT CURRENT, R.M.S. IQ OPTION 1 (KA)	50
RATED FUSED SHORT-CIRCUIT CURRENT, PEAK VALUE (KA)	22
RATED IMPULSE WITHSTAND VOLTAGE, UIMP (KV)	8
RATED SHORT-CIRCUIT MAKING CAPACITY, ICM 415 V (KA)	11.4
RATED SHORT-TIME WITHSTAND CURRENT 1 S, ICW 415 V (KA)	6.5

RATED BREAKING CAPACITY, AC- 23A 415 V (A)	1600
ELECTRICAL ENDURANCE (NUMBER OF OPERATIONS)	2000
MECHANICAL ENDURANCE (NUMBER OF OPERATIONS)	16000
TERMINAL / BOLT SIZE CU (MM ²)	M8
MAXIMUM TERMINAL TORQUE (NM)	15..22
SWITCH TYPE	Load Break Switch