

 **LoadSafe**
KUE 340 AD3KKUE

3x40A 690V AC-22

PRODUCT NUMBER	20081
GTIN	6419410200810
E-NUMBER FI	3635057
TECHNICAL NAME	3x40A 690V AC-22
ETIM CLASS	EC000216

MEASUREMENTS

HEIGHT	72 mm
WIDTH	53 mm
DEPTH	83 mm
VOLUME	0.3167 l
NET WEIGHT	0.2199 kg

DIMENSIONAL DRAWING

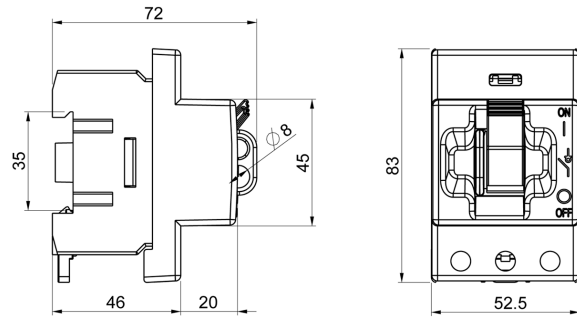

LOGISTICAL DATA

SALES UNIT	1
PACKAGE SIZE 1	1
PACKAGE SIZE 1 DEPTH	83 mm
PACKAGE SIZE 1 HEIGHT	72 mm
PACKAGE SIZE 1 WIDTH	83 mm
PACKAGE SIZE 1 WEIGHT	0.2199 kg
PACKAGE SIZE 1 VOLUME	0.496 l

TECHNICAL DATA

NUMBER OF POLES	3
ATEX	No
RATED OPERATIONAL CURRENT AC-23A 415 V, IE (A)	25
RATED OPERATIONAL CURRENT AC-23A 690 V, IE (A)	20
RATED OPERATIONAL POWER, 3- PHASE 1500 RPM SQUIRREL-CAGE MOTOR AC-23A 690 V (KW)	15
RATED INSULATION VOLTAGE, UI (V)	800
NOMINAL VALUES WITH CABLE SIZE (MM ²)	16
RATED THERMAL CURRENT, ITH (A)	63
RATED OPERATIONAL CURRENT AC-21A 415 V, IE (A)	63
RATED OPERATIONAL CURRENT AC-21A 500 V, IE (A)	63
RATED OPERATIONAL CURRENT AC-21A 690 V, IE (A)	63
RATED OPERATIONAL CURRENT AC-22A 415 V, IE (A)	40
RATED OPERATIONAL CURRENT AC-22A 500 V, IE (A)	40
RATED OPERATIONAL CURRENT AC-22A 690 V, IE (A)	40
RATED OPERATIONAL CURRENT AC-23A 500 V, IE (A)	20
RATED OPERATIONAL POWER, 3- PHASE 1500 RPM SQUIRREL-CAGE MOTOR AC-23A 415 V (KW)	11

RATED OPERATIONAL POWER, 3-PHASE 1500 RPM SQUIRREL-CAGE MOTOR AC-23A 500 V (KW)	11
RATED FUSED SHORT-CIRCUIT CURRENT, BACK-UP FUSE OPTION 1 (A)	63
RATED FUSED SHORT-CIRCUIT CURRENT, R.M.S. IQ OPTION 1 (KA)	50
RATED FUSED SHORT-CIRCUIT CURRENT, PEAK VALUE (KA)	7.2
RATED IMPULSE WITHSTAND VOLTAGE, UIMP (KV)	8
RATED SHORT-CIRCUIT MAKING CAPACITY, ICM 690 V (KA)	2.5
RATED SHORT-TIME WITHSTAND CURRENT 1 S, ICW 690 V (KA)	1.7
RATED BREAKING CAPACITY, AC-23A 415 V (A)	200
RATED BREAKING CAPACITY, AC-23A 500 V (A)	160
RATED BREAKING CAPACITY, AC-23A 690 V (A)	160
ELECTRICAL ENDURANCE (NUMBER OF OPERATIONS)	3000
MECHANICAL ENDURANCE (NUMBER OF OPERATIONS)	50000
TERMINAL / BOLT SIZE CU (MM ²)	1,5..16
MAXIMUM TERMINAL TORQUE (NM)	1.8
SWITCH TYPE	Load Break Switch