

 IsoSafe

ISF 430UL M2

4x25A 400V 11kW

PRODUCT NUMBER	29476
GTIN	6419410294765
E-NUMBER FI	3662550
TECHNICAL NAME	4x25A 400V 11kW
ETIM CLASS	EC000216

MEASUREMENTS

HEIGHT	130 mm
WIDTH	96 mm
DEPTH	104 mm
VOLUME	1.2979 l

LOGISTICAL DATA

PACKAGE SIZE 1	104 mm
DEPTH	
PACKAGE SIZE 1	130 mm
HEIGHT	
PACKAGE SIZE 1	96 mm
WIDTH	
PACKAGE SIZE 1	1.2979 l
VOLUME	

DIMENSIONAL DRAWING

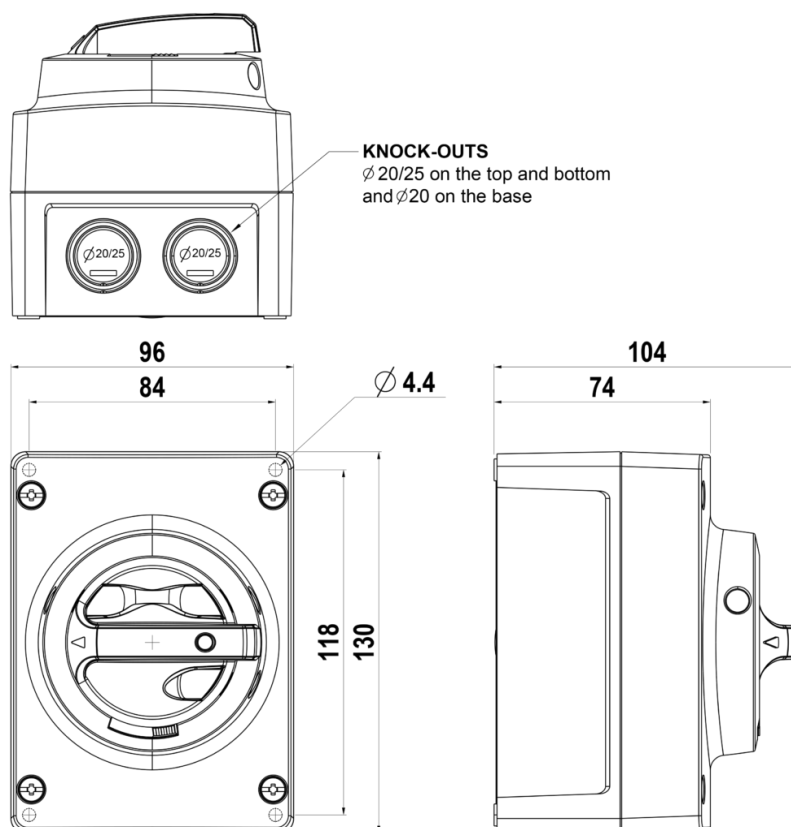

TECHNICAL DATA

NUMBER OF POLES	4
ENCLOSURE	M2 (96 x 130 x 74 mm)
ENCLOSURE TYPE	Polycarbonate
UL	UL 60947-4-1A
EMC	No
ATEX	No
IP RATING	IP66
AMPERE RATING (600V)	30
HP 208V	5
HP 480V	10
HP 600V	15
SWITCH TYPE DESCRIPTION	Manual motor controller
WIRE SIZE (CU ONLY)	14-8 AWG