



ConnectSafe KL1X150

PRODUCT NUMBER	37837
GTIN	6419410378373
E-NUMBER FI	1942055
ETIM CLASS	EC000897

MEASUREMENTS

HEIGHT	80 mm
WIDTH	30 mm
DEPTH	57 mm
VOLUME	0.1368 l
NET WEIGHT	0.2401 kg

LOGISTICAL DATA

PACKAGE SIZE 1	18
PACKAGE SIZE 1 WEIGHT	0.2401 kg

DIMENSIONAL DRAWING

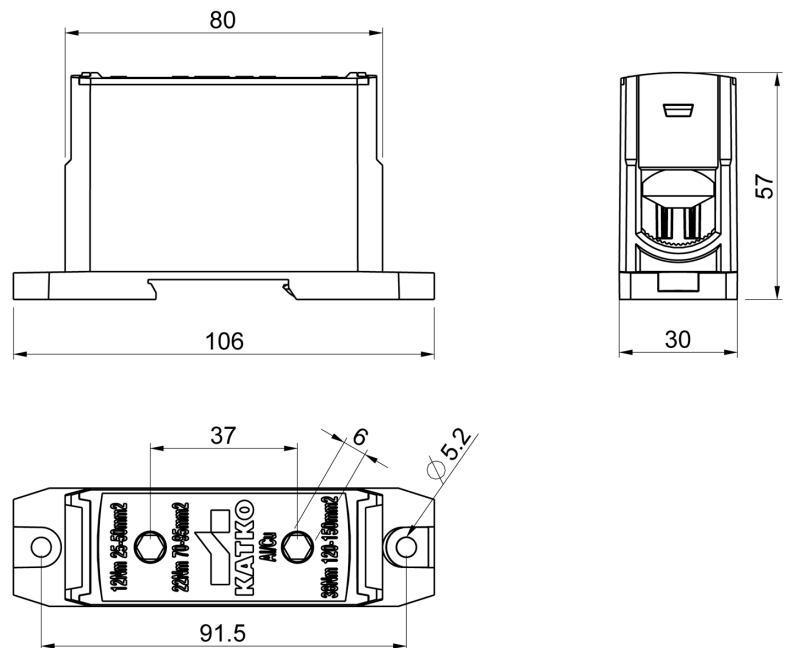

TECHNICAL DATA

UL	UL 1059, CAN/CSA C22.2 No. 158-10
ATEX	No
TORQUE AL/CU (NM)	12 (25 - 50 mm ²) / 22 (70 - 95 mm ²) / 38 (120 - 150 mm ²)
KEY SIZE	Hex 6
IN (AL) (A)	250
IN (CU) (A)	320
AL MM ²	25-150
CU MM ²	25-150
NOMINAL VOLTAGE	1000V AC / 1500V DC
LINE/LOAD WIRE SIZE-STR CU/AL (KCMIL/AWG)	300 - 2
TORQUE AL/CU LB-IN	110 (1/0 - 2 AWG) / 200 (4/0 - 2/0 AWG) / 340 (300 - 250 kcmil)
AMPERE AL (A)	230
AMPERE CU (A)	285