



ConnectSafe

KL2X240

PRODUCT NUMBER	37846
GTIN	6419410378465
E-NUMBER FI	1942076
ETIM CLASS	EC000897

MEASUREMENTS

HEIGHT	92 mm
WIDTH	66 mm
DEPTH	67 mm
VOLUME	0.4068 l
NET WEIGHT	0.6303 kg

LOGISTICAL DATA

PACKAGE SIZE 1	8
PACKAGE SIZE 1 WEIGHT	0.6303 kg

DIMENSIONAL DRAWING

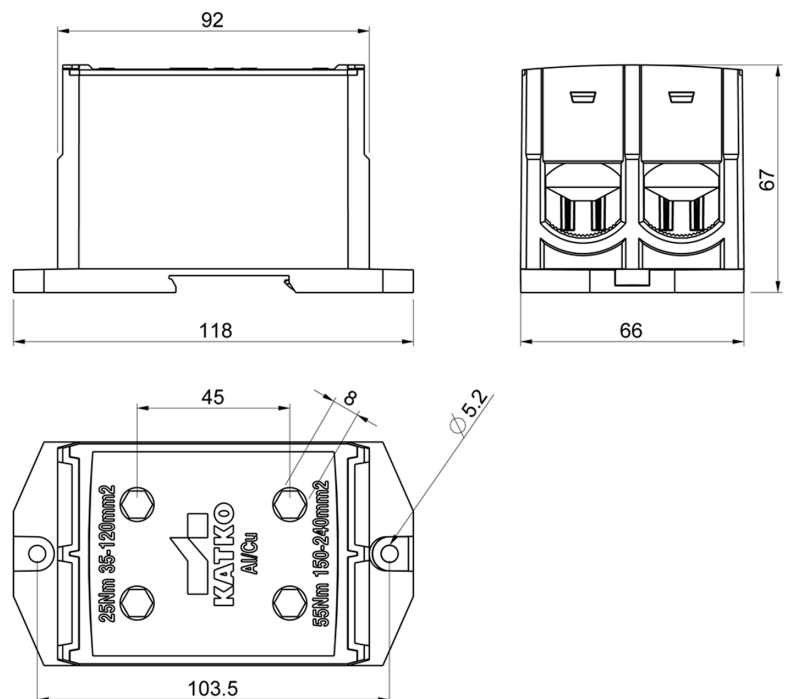

TECHNICAL DATA

UL	UL 1059, CAN/CSA C22.2 No. 158-10
ATEX	No
TORQUE AL/CU (NM)	25 (35 - 120 mm ²) / 55 (150 - 240 mm ²)
KEY SIZE	Hex 8
IN (AL) (A)	630
IN (CU) (A)	850
AL MM ²	35-240
CU MM ²	35-240
NOMINAL VOLTAGE	1000V AC / 1500V DC
LINE/LOAD WIRE SIZE-STR CU/AL (KCMIL/AWG)	500 - 3/0
TORQUE AL/CU LB-IN	220 (250 kcmil - 3/0 AWG) / 490 (500 - 300 kcmil)
AMPERE AL (A)	620
AMPERE CU (A)	760