



ConnectSafe

KL2X95M

PRODUCT NUMBER	33817
GTIN	6419410338179
E-NUMBER FI	1942156
ETIM CLASS	EC000897

MEASUREMENTS

HEIGHT	62.5 mm
WIDTH	42 mm
DEPTH	49 mm
VOLUME	0.1286 l

LOGISTICAL DATA

PACKAGE SIZE 1	12
----------------	----

DIMENSIONAL DRAWING

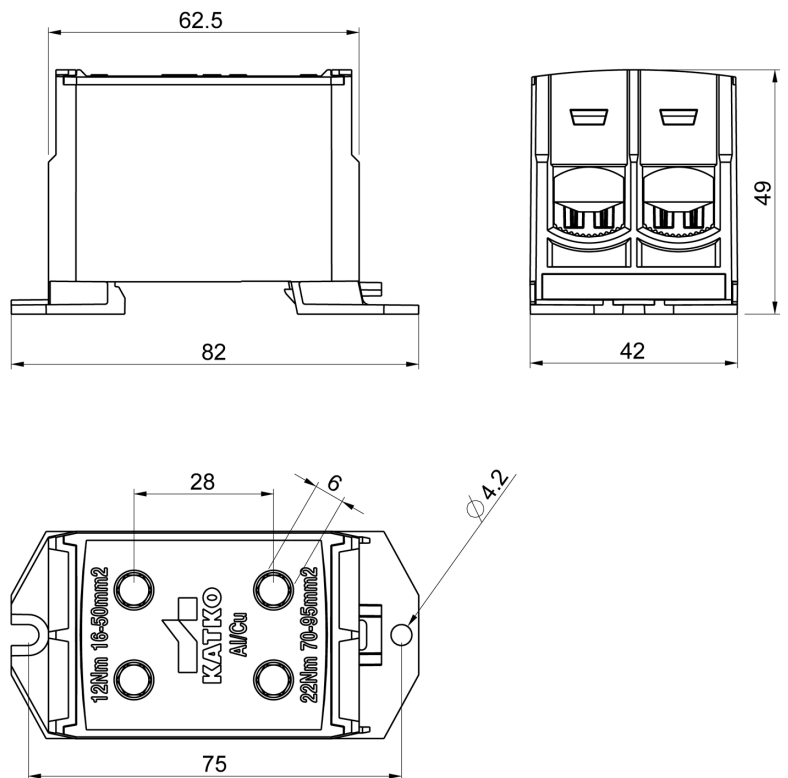

TECHNICAL DATA

ATEX	No
TORQUE AL/CU (NM)	12 (16 – 50 mm ²) / 22 (70 – 95 mm ²)
KEY SIZE	Hex 6
IN (AL) (A)	400
IN (CU) (A)	490
AL MM ²	6–95
CU MM ²	6–95
NOMINAL VOLTAGE	1000V AC / 1500V DC