

 IsoSafe

KER 4200C RA5

4x200A 400V 110kW

PRODUCT NUMBER	34784
GTIN	6419410347843
TECHNICAL NAME	4x200A 400V 110kW
ETIM CLASS	EC000216

MEASUREMENTS

HEIGHT	400 mm
WIDTH	300 mm
DEPTH	120 mm
VOLUME	14.4 l
NET WEIGHT	7.7192 kg

LOGISTICAL DATA

SALES UNIT	1
PACKAGE SIZE 1	1
PACKAGE SIZE 1	120 mm
DEPTH	
PACKAGE SIZE 1	400 mm
HEIGHT	
PACKAGE SIZE 1	300 mm
WIDTH	
PACKAGE SIZE 1	7.7192 kg
WEIGHT	
PACKAGE SIZE 1	14.4 l
VOLUME	

DIMENSIONAL DRAWING

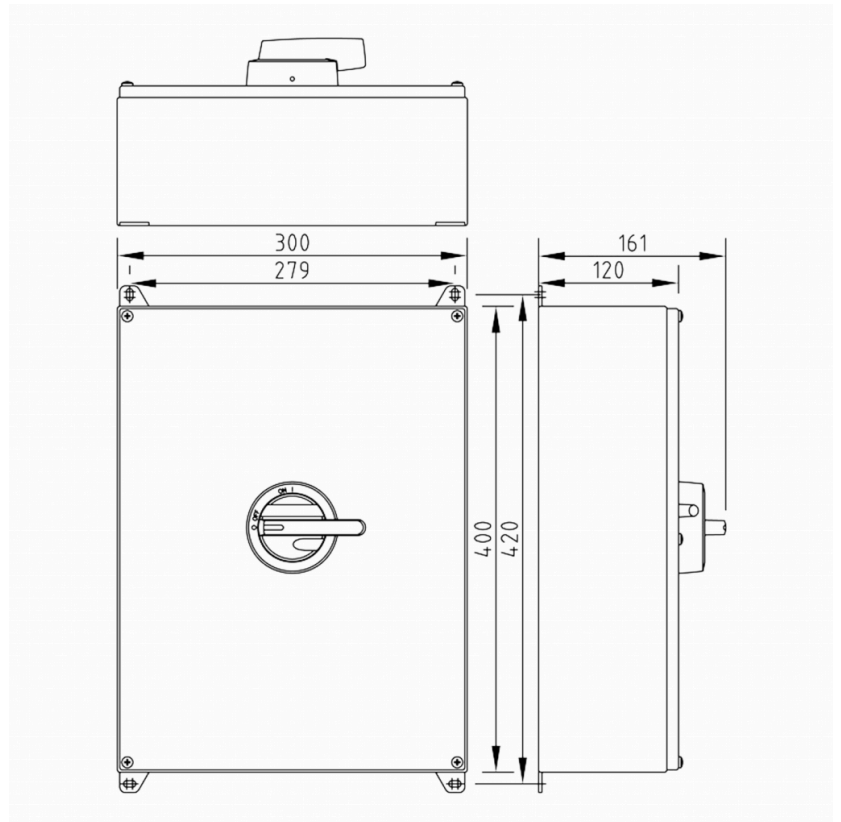

TECHNICAL DATA

NUMBER OF POLES	4
ENCLOSURE	RA5 (300 x 400 x 120 mm)
ENCLOSURE TYPE	Stainless steel enclosure (AISI 316L)
EMC	No
ATEX	No
IP RATING	IP66
RATED OPERATIONAL CURRENT AC-23A 415 V, IE (A)	200
RATED INSULATION VOLTAGE, UI (V)	1000
SWITCH TYPE DESCRIPTION	Isolating switch
NOMINAL VALUES WITH CABLE SIZE (MM ²)	95
RATED THERMAL CURRENT, ITH (A)	200
RATED THERMAL CURRENT (ENCLOSED), ITHE (A)	200
RATED OPERATIONAL CURRENT AC-21A 415 V, IE (A)	200
RATED OPERATIONAL CURRENT AC-21A 500 V, IE (A)	200
RATED OPERATIONAL CURRENT AC-21A 690 V, IE (A)	200
RATED OPERATIONAL CURRENT AC-22A 415 V, IE (A)	200
RATED OPERATIONAL POWER, 3-PHASE 1500 RPM SQUIRREL-CAGE MOTOR AC-23A 415 V (KW)	110
RATED FUSED SHORT-CIRCUIT CURRENT, BACK-UP FUSE OPTION 1 (A)	250
RATED FUSED SHORT-CIRCUIT CURRENT, R.M.S. IQ OPTION 1 (KA)	50
RATED FUSED SHORT-CIRCUIT CURRENT, PEAK VALUE (KA)	22

RATED IMPULSE WITHSTAND VOLTAGE, UIMP (KV)	8
RATED SHORT-CIRCUIT MAKING CAPACITY, ICM 415 V (KA)	11.4
RATED SHORT-TIME WITHSTAND CURRENT 1 S, ICW 415 V (KA)	6.5
RATED BREAKING CAPACITY, AC-23A 415 V (A)	1600
ELECTRICAL ENDURANCE (NUMBER OF OPERATIONS)	2000
MECHANICAL ENDURANCE (NUMBER OF OPERATIONS)	16000
TERMINAL / BOLT SIZE CU (MM ²)	M8
MAXIMUM TERMINAL TORQUE (NM)	15..22
SWITCH TYPE	Load Break Switch