



ConnectSafe

KL2X150M

PRODUCT NUMBER	33821
GTIN	6419410338216
E-NUMBER FI	1942160
ETIM CLASS	EC000897

MEASUREMENTS

HEIGHT	80 mm
WIDTH	52 mm
DEPTH	57 mm
VOLUME	0.2371 l

LOGISTICAL DATA

PACKAGE SIZE 1	10
----------------	----

DIMENSIONAL DRAWING

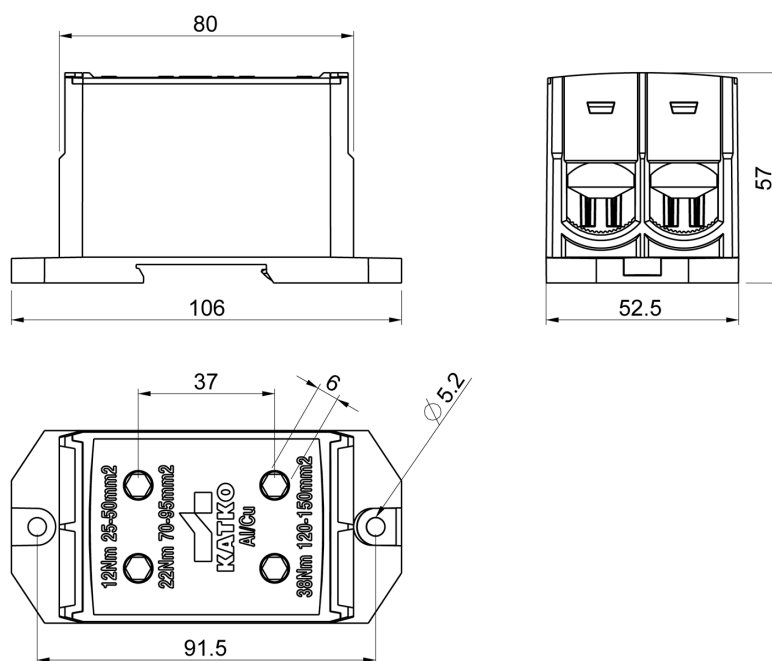

TECHNICAL DATA

ATEX	No
TORQUE AL/CU (NM)	12 (25 - 50 mm ²) / 22 (70 - 95 mm ²) / 38 (120 - 150 mm ²)
KEY SIZE	Hex 6
IN (AL) (A)	500
IN (CU) (A)	640
AL MM ²	25-150
CU MM ²	25-150
NOMINAL VOLTAGE	1000V AC / 1500V DC